

Sunlord

SPECIFICATIONS

Customer	
Product Name	Multi-layer Chip Ferrite Beads
Sunlord Part Number	PZ2012D600-3R0TF
Customer Part Number	

New Released, Revised]

SPEC No.: **PZ201260**

Rev.	Effective Date	Changed Contents	Change reasons	Approved By
01	/	New release	/	Hai Guo

【 This SPEC is total 10 pages.】

【 RoHS Compliant Parts】

Approved By	Checked By	Issued By
		

Shenzhen Sunlord Electronics Co., Ltd.

Address: Sunlord Industrial Park, Dafuyuan Industrial Zone, Guanlan, Shenzhen, China 518110
Tel: 0086-755-82400574 Fax: 0086-755-82269029 E-Mail: sunlord@sunlordinc.com

【For Customer approval Only】

Date: _____

Qualification Status: Full Restricted Rejected

Approved By	Verified By	Re-checked By	Checked By

Comments:

Table of Contents

1. Scope	3
2. Reference Documents	3
3. Product Descriptions and Identification (Part Number)	3
4. Electrical Characteristics	3
5. Shape and Dimensions	4
6. Test and Measurement Procedures	4~6
6.1 Test Conditions	4
6.2 Visual Examination	4
6.3 Electrical Test	4~5
6.3.1 DC Resistance	4
6.3.2 Impedance	4
6.3.3 Rated Current	5
6.4 Reliability Test	5~6
6.4.1 Terminal Strength	5
6.4.2 Resistance to Flexure	5
6.4.3 Vibration	5
6.4.4 Dropping	5
6.4.5 Temperature Characteristics	5
6.4.6 Solderability	5
6.4.7 Resistance to Soldering Heat	6
6.4.8 Thermal Shock	6
6.4.9 Resistance to Low Temperature	6
6.4.10 Resistance to High Temperature	6
6.4.11 Damp Heat (Steady State)	6
6.4.12 Loading Under Damp Heat	6
6.4.13 Loading at High Temperature(Life Test)	6
7. Packaging Storage and Transportation	6~8
7.1 Packaging	6~7
7.2 Storage	8
7.3 Transportation	8
7.4 General Handling Precautions	8
7.5 Precautions on Use	8
8. Packaging Documents and Marking	8~9
8.1 Packaging Documents	8
8.2 Marking	8~9
9. Recommended Soldering Technologies	9~10
9.1 RE-flowing Profile	9
9.2 Iron Soldering Profile	9
9.3 Solder Volume	9
9.4 Attention Regarding PCB Bending	10
9.5 Cleaning	10
10. Supplier Information	10

1. Scope

This specification applies to PZ2012D600-3R0TF multi-layer ferrite chip beads.

2. Applied Documents

- EIA/IS-759 Multi-layer Chip Bead Qualification Specification.
- MIL-STD-202 Test Methods for Electronic and Electrical Chip Parts.
- IEC-68 Test Methods for Environmental Testing.

3. Product Description and Identification (Part Number)

- 1) Description:
Ferrite Bead, 2012, 60Ω @ 100MHz, 0.02Ω DCR, 3000mA
- 2) Product Identification (Part Number)

PZ 2012 D 600 -3R0 T F
 ① ② ③ ④ ⑤ ⑥ ⑦

①	Type
PZ	For Large current

②	External Dimensions (L X W) [mm]	
2012 [0805]	2.0 X 1.25	

③	Material Code
D	

④	Nominal	Impedance
Example	Nominal Value	
600	60 Ω	

⑤	Rate Current
3R0	3.0 A

⑥	Packing	
B	Bulk Package	
T	Tape Carrier Package	

⑦	HSF Products
Hazardous Substance Free Products	

4. Electrical Characteristics

Part Number	Impedance (Ω)	Z Test Freq.(MHz)	DCR (Ω) Max.	Ir (mA) Max.
PZ2012D600	60±25%	100	0.02	3000

Impedance Frequency Characteristics

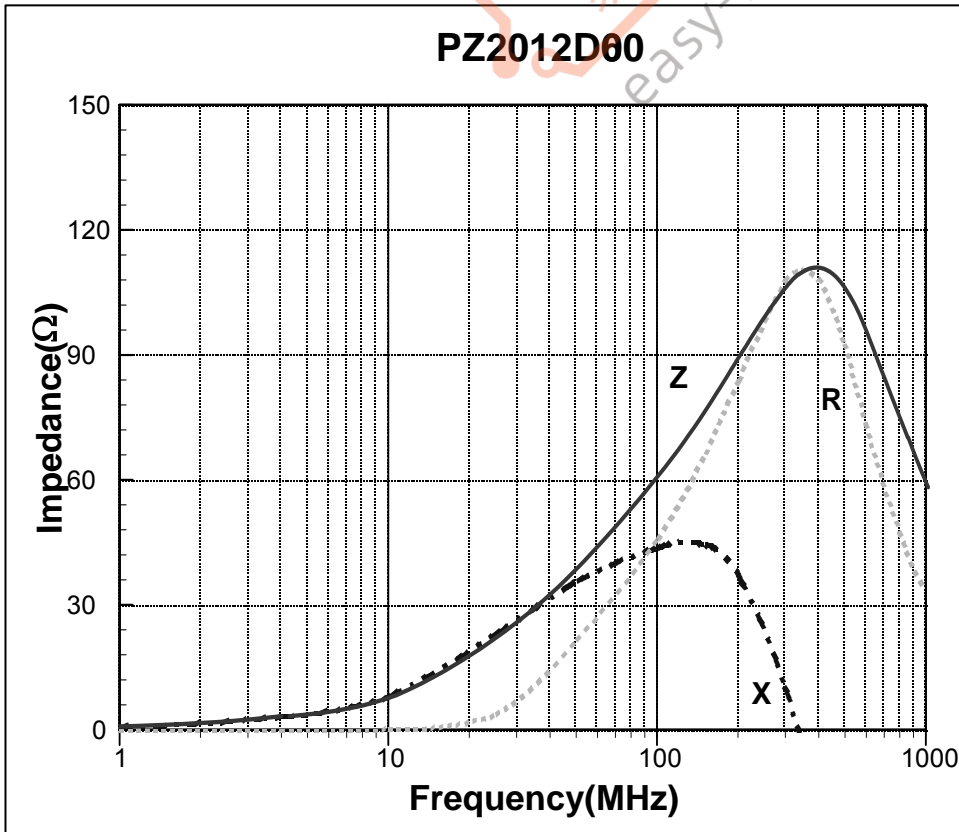

- 1) Operating and storage temperature range (individual chip without packing): -40°C to +85°C
- 2) Storage temperature range (packaging conditions): -10°C ~ +40°C and RH 70% (Max.)

5. Shape and Dimensions

- 1) Dimensions and recommended PCB pattern for reflow soldering: See Fig.5-1, Fig.5-2 and Table 5-1
- 2) Structure: See Fig. 5-3 and Fig. 5-4

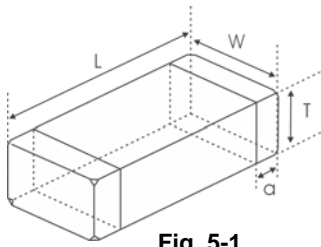

Fig. 5-1

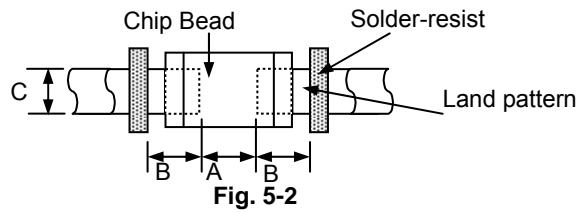

Fig. 5-2

[Table 5-1]

Unit: mm [inch]

Type	L	W	T	a	A	B	C
2012 [0805]	2.0 (+0.3, -0.1) [0.079 (+0.012, -0.004)]	1.25±0.2 [0.049±0.008]	0.85±0.2 [0.033±0.008]	0.5±0.3 [0.020±0.012]	0.80~ 1.20	0.80~ 1.20	0.90~ 1.60

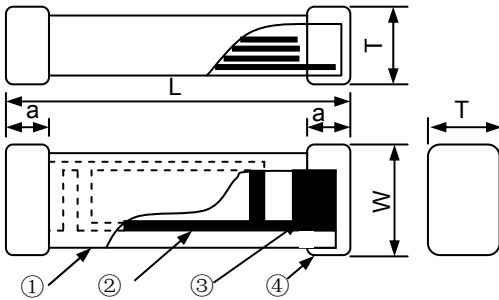

Fig. 5-3

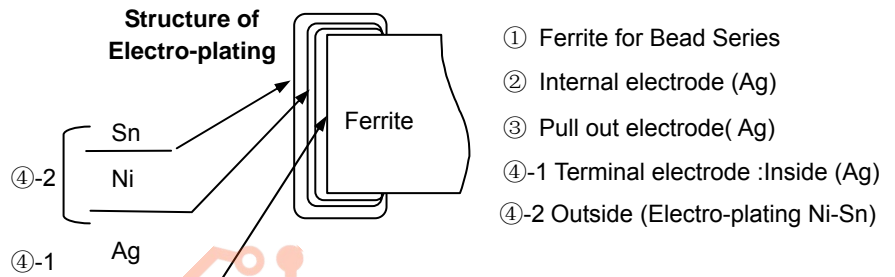

Fig. 5-4

- ① Ferrite for Bead Series
- ② Internal electrode (Ag)
- ③ Pull out electrode (Ag)
- ④-1 Terminal electrode :Inside (Ag)
- ④-2 Outside (Electro-plating Ni-Sn)

Material Information

Code	Part Name	Material Name
①	Ferrite Body	Ferrite Powder
②	Inner Coils	Silver Paste
③	Pull-out Electrode (Ag)	Silver Paste
④-1	Terminal Electrode: Inside Ag	Termination Silver Composition
④-2	Electro-Plating: Ni/Sn plating	Plating Chemicals

6. Test and Measurement Procedures

6.1 Test Conditions

Unless otherwise specified, the standard atmospheric conditions for measurement/test as:

- a. Ambient Temperature: 20±15°C
- b. Relative Humidity: 65±20%
- c. Air Pressure: 86 KPa to 106 KPa

If any doubt on the results, measurements/tests should be made within the following limits:

- a. Ambient Temperature: 20±2°C
- b. Relative Humidity: 65±5%
- c. Air Pressure: 86KPa to 106 KPa

6.2 Visual Examination

- a. Inspection Equipment: 20 X magnifier

6.3 Electrical Test

6.3.1 DC Resistance (DCR)

- a. Refer to Item 4.
- b. Test equipment (Analyzer): High Accuracy Milliohmmeter-HP4338B

6.3.2 Impedance (Z)

- a. Refer to Item 4.
- b. Test equipment:High Accuracy RF Impedance /Material Analyzer-HP4291B+16192A
- c. Test signal: -20dBm or 50mV
- d. Test frequency refers to Item 4.

6.3.3 Rated Current

- a. Refer to Item 4.
- b. Test equipment (see Fig.6.3.3-1): Electric Power, Electric current meter, Thermometer.
- c. Measurement method (see Fig. 6.3.3-1):
 - 1. Set test current to be 0 mA.
 - 2. Measure initial temperature of chip surface.
 - 3. Gradually increase voltage and measure chip temperature for corresponding current.
- d. Definition of Rated Current(IDC): IDC is direct electric current as chip surface temperature rose just 20°C against chip initial surface temperature(Ta). (see Fig. 6.3.3-2):

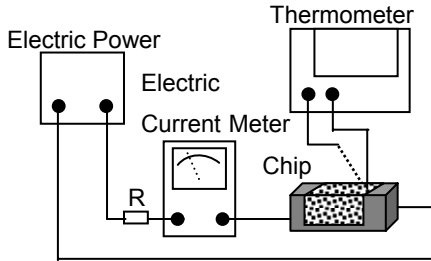

Fig. 6.3.3-1

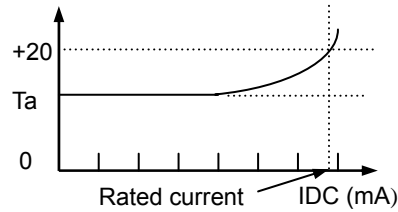

Fig. 6.3.3-2

6.4 Reliability Test

Items	Requirements	Test Methods and Remarks								
6.4.1 Terminal Strength	No removal or split of the termination or other defects shall occur. Fig.6.4.1-1	<ul style="list-style-type: none"> ① Solder the bead to the testing jig (glass epoxy board shown in Fig.6.4.1-1) using eutectic solder. Then apply a force in the direction of the arrow. ② 10N force for 2012 series. ③ Keep time: 10±1s ④ Speed:1.0mm/s. 								
6.4.2 Resistance to Flexure	No visible mechanical damage. Unit: mm [inch] <table border="1" style="margin-left: auto; margin-right: auto;"> <thead> <tr> <th>Type</th> <th>a</th> <th>b</th> <th>c</th> </tr> </thead> <tbody> <tr> <td>2012[0805]</td> <td>1.2</td> <td>4.0</td> <td>1.65</td> </tr> </tbody> </table> Fig.6.4.2-1	Type	a	b	c	2012[0805]	1.2	4.0	1.65	<ul style="list-style-type: none"> ① Solder the bead to the test jig (glass epoxy board shown in Fig.6.4.2-1) Using a eutectic solder. Then apply a force in the direction shown Fig. 6.4.2-2. ② Flexure: 2mm ③ Pressurizing Speed: 0.5mm/sec. ④ Keep time: 30 sec. Fig.6.4.2-2
Type	a	b	c							
2012[0805]	1.2	4.0	1.65							
6.4.3 Vibration	<ul style="list-style-type: none"> ① No visible mechanical damage. ② Impedance change: within ±20% Fig. 6.4.3-1	<ul style="list-style-type: none"> ① Solder the bead to the testing jig (glass epoxy board shown in Fig.6.4.3-1) using eutectic solder. ② The bead shall be subjected to a simple harmonic motion having total amplitude of 1.5mm, the frequency being varied uniformly between the approximate limits of 10 and 55 Hz. ③ The frequency range from 10 to 55 Hz and return to 10 Hz shall be traversed in approximately 1 minute. This motion shall be applied for a period of 2 hours in each 3 mutually perpendicular directions (total of 6 hours) 								
6.4.4 Dropping	<ul style="list-style-type: none"> ① No visible mechanical damage. ② Impedance change: within ±20% 	Drop chip bead 10 times on a concrete floor from a height of 100 cm.								
6.4.5 Temperature	Impedance change should be within ±20% of initial value measuring at 20°C.	Temperature range: -40°C to +85°C Reference temperature: +20°C								
6.4.6 Solderability	<ul style="list-style-type: none"> ① No visible mechanical damage. ② Wetting shall exceed 95% coverage. 	<ul style="list-style-type: none"> ① Solder temperture: 240±2°C ② Duration: 3 sec. ③ Solder: Sn/3.0Ag/0.5Cu ④ Flux: 25% Resin and 75% ethanol in weight. 								

6.4.7 Resistance to Soldering Heat	<ul style="list-style-type: none"> ① No visible mechanical damage. ② Wetting shall exceed 95% coverage. ③ Impedance change: within $\pm 20\%$ 	<ul style="list-style-type: none"> ① Solder temperature :$260\pm 3^{\circ}\text{C}$ ② Duration: 5 sec. ③ The chip shall be stabilized at normal condition for 1~2hours before measuring. ④ Solder: Sn/3.0Ag/0.5Cu ⑤ Flux: 25% Resin and 75% ethanol in weight
6.4.8 Thermal Shock	<ul style="list-style-type: none"> ① No mechanical damage. ② Impedance change: Within $\pm 20\%$ <div style="text-align: center;"> <p>Fig. 6.4.8-1</p> </div>	<ul style="list-style-type: none"> ① Temperature, Time: (See Fig.6.4.8-1). -40°C for 30±3 min → +85°C for 30±3min ② Transforming interval: Max. 20 sec. ③ Tested cycle: 100 cycles ④ The chip shall be stabilized at normal condition for 1~2 hours before measuring.
6.4.9 Resistance to Low Temperature	<ul style="list-style-type: none"> ① No mechanical damage. ② Impedance change: within $\pm 20\%$ 	<ul style="list-style-type: none"> ① Temperature: $-40\pm 2^{\circ}\text{C}$ ② Duration: 1000⁺²⁴ hours ③ The chip shall be stabilized at normal condition for 1~2 hours before measuring.
6.4.10 Resistance to High Temperature	<ul style="list-style-type: none"> ① No mechanical damage. ② Impedance change: within $\pm 20\%$ 	<ul style="list-style-type: none"> ① Temperature: $85\pm 2^{\circ}\text{C}$ ② Duration: 1000⁺²⁴ hours ③ The chip shall be stabilized at normal condition for 1~2 hours before measuring.
6.4.11 Damp Heat (Steady States)	<ul style="list-style-type: none"> ① No visible mechanical damage. ② Impedance change: within $\pm 20\%$ 	<ul style="list-style-type: none"> ① Temperature: $55\pm 2^{\circ}\text{C}$ ② Humidity: 90% to 95% RH ③ Duration: 1000⁺²⁴ hours ④ The chip shall be stabilized at normal condition for 1~2 hours before measuring.
6.4.12 Loading Under Damp Heat	<ul style="list-style-type: none"> ① No visible mechanical damage. ② Impedance change: within $\pm 20\%$ 	<ul style="list-style-type: none"> ① Temperature: $55\pm 2^{\circ}\text{C}$ ② Humidity: 90% to 95% RH ③ Duration: 1000⁺²⁴ hours ④ Applied current: Rated current. ⑤ The chip shall be stabilized at normal condition for 1~2 hours before measuring.
6.4.13 Loading at High Temperature (Life Test)	<ul style="list-style-type: none"> ① No visible mechanical damage. ② Impedance change: within $\pm 20\%$ 	<ul style="list-style-type: none"> ① Temperature: $+85\pm 2^{\circ}\text{C}$ ② Duration: 1000⁺²⁴ hours ③ Applied current: Rated current. ④ The chip shall be stabilized at normal condition for 1~2hours before measuring.

7. Packaging, Storage and Transportation

7.1 Packaging

There are two types of packaging for the chip beads. Please specify the packing code when ordering.

7.1.1 Bulk Packaging:

Packaging code: B, The quantity of each bag is integral multiple of 1000.

Remark: The actual quantity in a package may change sometimes.

7.1.2 Tape Carrier Packaging:

Packaging code: T

a. Tape carrier packaging are specified in attached figure **Fig.7.1-1~4**

b. Tape carrier packaging quantity please see the following table:

Type	2012[0805]
T(mm)	0.85±0.2
Tape	Paper Tape
Quantity	4K

c. Reel shall be packaged in vinyl bag.

d. Maximum of 5 or 10 reels bags shall be packaged in an inner box.

e. Maximum of 6 or 10 inner boxes shall be packaged in an outer case.

(1) Taping Drawings (Unit: mm)

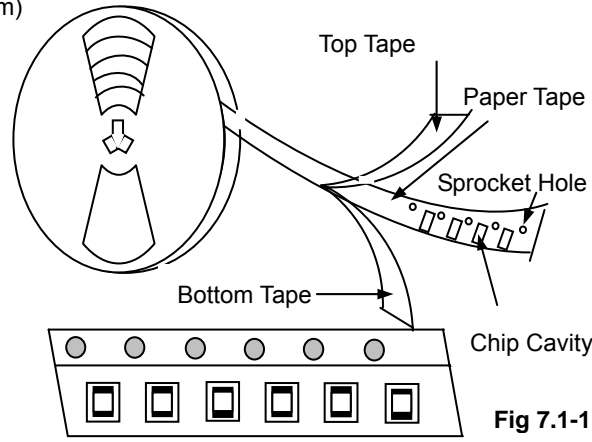

Remark: The sprocket holes are to the right as the tape is pulled toward the user.

(2) Taping Dimensions (Unit: mm)

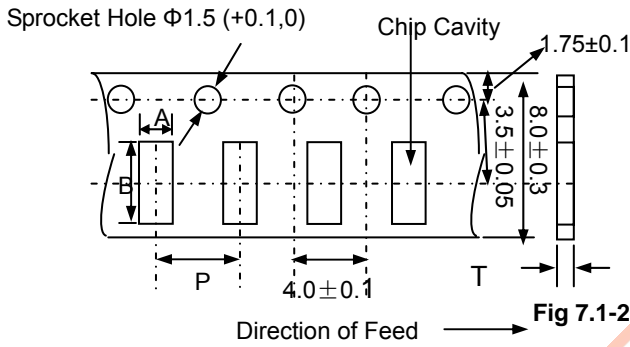

Paper Tape

Type	A	B	P	T max
2012 [0805]	1.5 ± 0.2	2.3 ± 0.2	4.0 ± 0.1	1.1

(3) Reel Dimensions (Unit: mm)

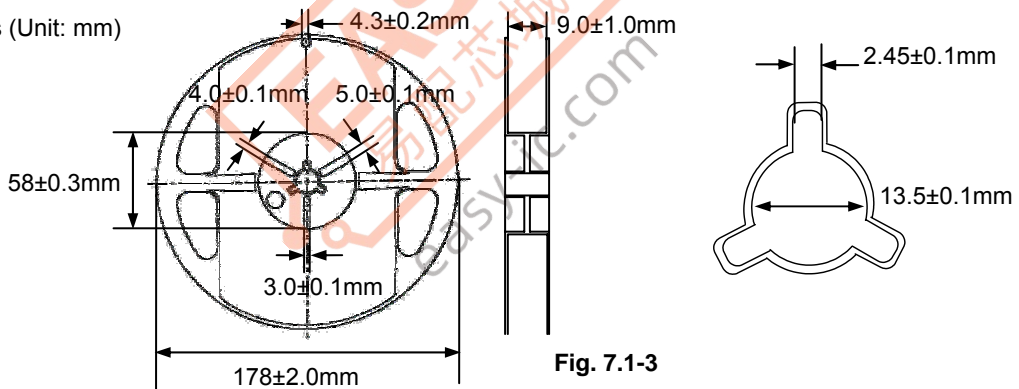

(4) Leader and Blank Portion

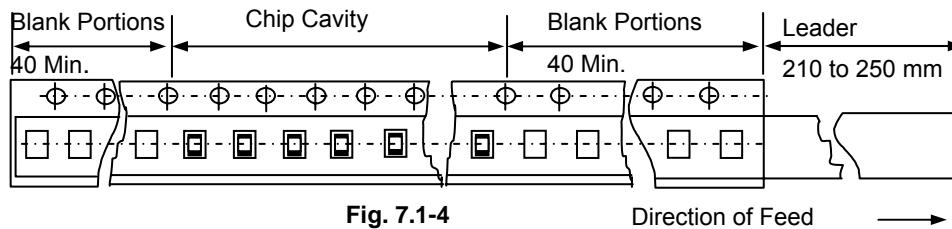

- (5) Missing beads number within 0.1% of the number per reel or 1 pcs, whichever is greater, and are not continuous.
- (6) The top tape and bottom tape shall not protrude beyond the edges of the tape and shall not cover sprocket hole.
- (7) Cumulative tolerance of sprocket holes, 10 pitches: ± 0.3 mm
- (8) Peeling off force: 10gf to 70gf in the direction show below.

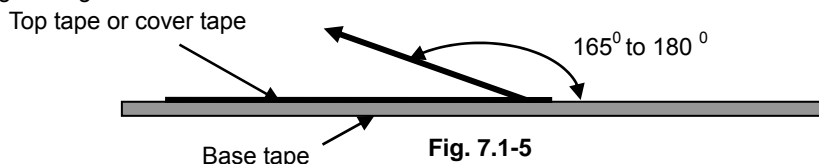

7.2 Storage

- a. The solderability of the external electrode may be deteriorated if packages are stored where they are exposed to high humidity. Package must be stored at 40°C or less and 70% RH or less.

- b. The solderability of the external electrode may be deteriorated if packages are stored where they are exposed to dust of harmful gas (e.g. HCl, sulfurous gas of H₂S)
- c. Packaging material may be deformed if package are stored where they are exposed to heat of direct sunlight.
- d. Minimum packages, such as polyvinyl heat-seal packages shall not be opened until they are used. If opened, use the reels as soon as possible.
- e. Solderability specified in **Clause 6.4.6** shall be guaranteed for 3 months from the date of delivery on condition that they are stored at the environment specified in **Clause 4** .For those parts, which passed more than 3 months shall be checked solder-ability before use.

7.3 Transportation

The cases shall not be damaged, destroyed and rained on.

7.4 General Handling Precautions

- a. Always wear static control bands to protect against ESD.
- b. Any devices used with the beads (soldering iron, measuring instruments) should be properly grounded.
- c. Keep bare hands and metal conductors (i.e., metal desk) away from chip electrodes or conductive areas that lead to chip electrodes.

7.5 Precautions on Use

- a. Pre-heating when soldering, see detail in **Clause 9** in this specification.
- b. When splitting the PC board after mounting beads and other components, care is required so as not to give any stress of deflection or twisting to the board.
- c. Don't apply current in excess of the rated current value. It may reduce the impedance due to the temperature increase effect.
- d. Always wear static control bands to protect against ESD.
- e. Keep clear of anything that may generate magnetic fields such as speakers, coils.
- f. When Soldering, the impedance may be varied due to hot energy and mechanical stress.
- g. Mounting ships with adhesive in preliminary assembly, before the soldering stage, may lead appropriately checked; the size of land pattern, type of adhesive, amount applied, hardening of the adhesive on proper usage and amounts of adhesive to use.
- h. Mounting Density: Add special attention to radiating heat of products when mounting the beads near the products with heating. The excessive heat by other products may cause deterioration at joint of this product with substrate.

8. Packing Documents and Marking

8.1 Packing documents

Packing documents include the following:

- a. Packaging list
- b. Certificate of compliance (COC)

8.2 Marking

1. Marking label information on reels includes (see **Fig.8.2-1~2**):

- a. Customer
- b. Customer part No.
- c. Customer P/O#
- d. Sunlord part No.
- e. Date code
- f. Lot number
- g. Quantity per reel
- h. Inspection stamp
- i. MFG address as 'MADE IN CHINA'

2. Marking label on inner box (see **Fig.8.2-3~4**):

- a. Customer
- b. Customer part No.
- c. Customer P/O#
- d. Sunlord part No.
- e. Date code
- f. Quantity per reel
- g. Manufacturer

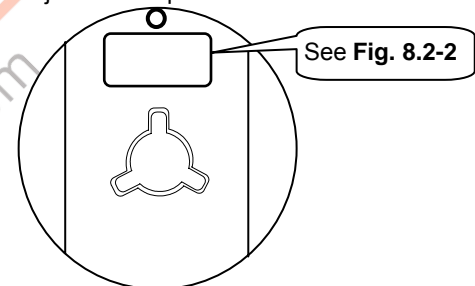

Fig. 8.2-1

Customer:	P/O NO.:
Cust Part NO.:	Quantity:
Sunlord Part NO.:	Datecode:
Lot NO.:	QA 22-9-2005 PASS
Sunlord	
SHENZHEN SUNLORD ELECTRONICS CO.,LTD. MADE IN CHINA	

Fig. 8.2-2: Marking label on reels

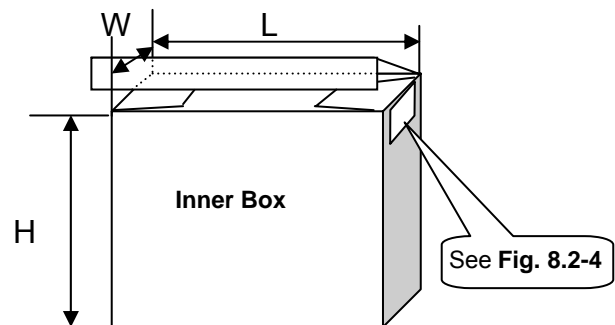



Fig. 8.2-3

Customer:	P/O NO.:
Cust Part NO.:	Quantity:
Sunlord Part NO.:	Datecode:



Sunlord
SHENZHEN SUNLORD ELECTRONICS CO.,LTD. MADE IN CHINA

	Packaging type	L(cm)	W(cm)	H(cm)
①	Inner Box- 1	18	7.5	18
②	Inner Box- 2	18	12	18

Fig. 8.2-4: Marking Label on inner box

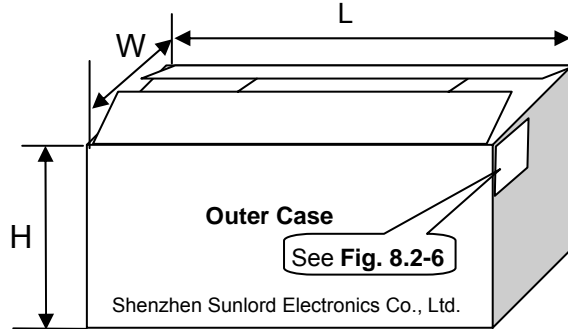

Fig. 8.2-5

3. Marking on outer case (see Fig.8.2-5~6):

- a. Manufacturer: Sunlord ID: "Shenzhen Sunlord Electronics Co., Ltd."
- b. Packing label include the following:
 - i) Customer
 - ii) Manufacture
 - iii) Date code
 - iv) C/No.
Example; "1/10" means this case is the 1st one of total 10 cases
 - v) P/O No.
 - vi) Customer P/N
 - vii) Sunlord P/N
 - viii) QT*Y(K)

	Packaging type	L(cm)	W(cm)	H(cm)
①	Outer Case- 1	40	20	20
②	Outer Case- 2	40	20	40

Sunlord	Customer			DATE CODE
	Manufacturer	SHEN ZHEN SUNLORD ELECTRONICS CO.,LTD		
C/No.	P/O No.	Customer P/N	Sunlord P/N	QT*Y(K)

Fig. 8.2-6: Marking label on outer case

9. Recommended Soldering Technologies

9.1 Re-flowing Profile:

- △ 1~2 °C/sec. Ramp
- △ Pre-heating: 150~190°C/120±30 sec.
- △ Time above 240°C: 20~60sec
- △ Peak temperature: 260°C Max.
- △ Solder paste: Sn/3.0Ag/0.5Cu
- △ Max.2 times for Re-flowing

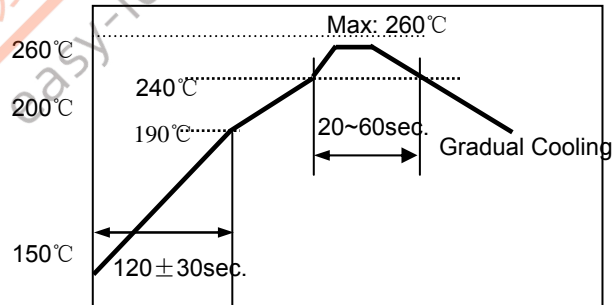

9.2 Iron Soldering Profile.

- △ Iron soldering power: Max.30W
- △ Pre-heating: 150 °C / 60 sec.
- △ Soldering Tip temperature: 350°C Max.
- △ Soldering time: 3 sec Max.
- △ Solder paste: Sn/3.0Ag/0.5Cu
- △ Max.1 times for iron soldering

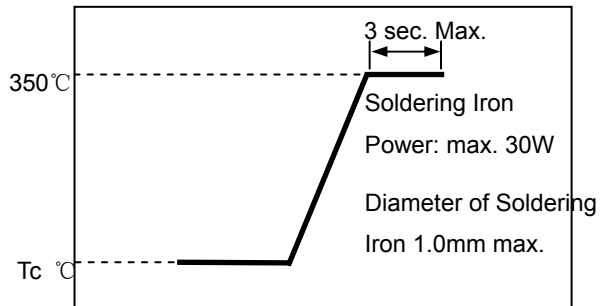

[Note: Take care not to apply the tip of the soldering iron to the terminal electrodes.]

9.3 Solder Volume

Solder shall be used not to exceed as shown below.

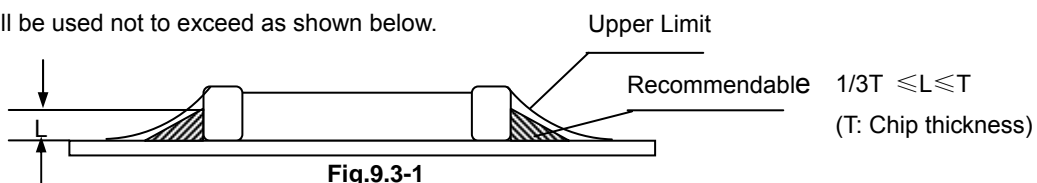

Accordingly increasing the solder volume, the mechanical stress to product is also increased. Exceeding solder volume may cause the failure of mechanical or electrical performance.

9.4 Attention Regarding PCB Bending

The following shall be considered when designing and laying out PCB's.

- (1) PCB shall be designed so that products are not subjected to the mechanical stress from board warp or deflection.

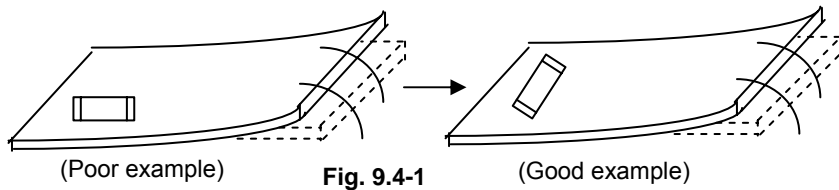

Products shall be located in the sideways direction to the mechanical stress

- (2) Products location on PCB separation.

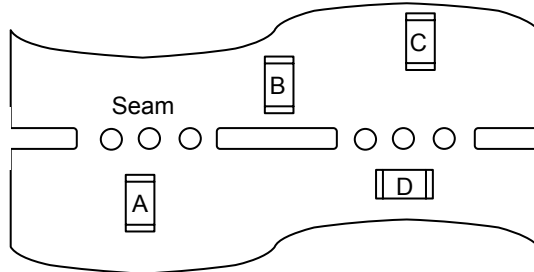

Product shall be located carefully because they may be subjected to the mechanical stress in order of $A > C = B > D$.

Fig. 9.4-2

9.5 Cleaning

Products shall be cleaned on the following conditions:

- (1) Cleaning temperature shall be limited to 60°C Max. (40°C Max. for fluoride and alcohol type cleaner.)
 (2) Ultrasonic cleaning shall comply with the following conditions, avoiding the resonance phenomenon at the mounted products and PCB.

Power: 20W/l Max.

Frequency: 28KHz to 40 KHz

Time: 5 minutes Max

- (3) Cleaner

① Alternative cleaner

- i. Isopropyl alcohol (IPA)
- ii. HCFC-225

② Aqueous agent

- Surface Active Agent Type (Clean through-750H)
- Hydrocarbon Type (Techno Cleaner-335)
- Higher Alcohol Type (Pine Alpha ST-100S)
- Alkali saponifier Type (※ Aqua Cleaner 240)

※ Alkali saponification shall be diluted to 20% volume with de-ionized water.

- (4) There shall be no residual flux and residual cleaner after cleaning. In the case of using aqueous agent, product shall be dried completely after rinse with de-ionized water in order to remove the cleaner.
 (5) Some products may become slightly whitened. However, product performance or usage is not affected.

10. Supplier Information

- a) Supplier:

Shenzhen Sunlord Electronics Co., Ltd

- b) Manufacturer

Shenzhen Sunlord Electronics Co., Ltd

- c) Manufacturing Address:

Sunlord Industrial Park, Dafuyuan Industrial Zone, Guanlan, Shenzhen, China

Zip: 518110